

Installation Manual

Grodan GroSens MultiSensor System



Table of contents

4

1 Introduction

1.1	Before installation	4
1.2	Installation steps	5

6

2 Hardware installation

2.1	General	6
2.2	Connecting first set of cables	6
2.3	Smartbox	7
2.4	Connecting second set of cables	7
2.5	GroSens Sensors	8
2.6	How to install the Sensors in the greenhouse	9
2.7	Setting the correct plate height	9

10

3 Software installation Smartbox

3.1	General	10
3.2	Login	10
3.3	Devices section	11
3.4	Irrigation section and Sensors	11
3.5	Other devices	12
3.6	Create new section	12
3.7	Section settings	13
3.8	Monitoring - adding and configuring Sensors	14
	3.8.1 Adding Sensors	14
	3.8.2 Row and offset - configuring a Sensor	15
3.9	Sunrise/sunset and lighting setup	16
3.10	System date, time and time zone	17
3.11	Update	17
3.12	Manage users - authorisation levels	18

19

4 Connection to climate computer

4.1	Hardware installation	19
4.2	Software installation	20
4.3	Converter settings	20

21

5 Troubleshooting

21

6 Maintenance

21

7 Range and accuracy

22

8 Warranty

22

9 Appendices

9.1	Sensor	22
9.2	Reader	23
9.3	Receiver	23
9.4	GroSens Smartbox	24
9.5	Converter (climate computer analogue interface)	25
9.6	Overview of standard GroSens System	26
9.7	Radio Frequency - declaration of Conformity	28

1 Introduction

This manual will guide you through the installation of the Grodan GroSens System. The GroSens System consists of several separate components:

- GroSens Sensors
- GroSens Receiver
- GroSens Reader
- GroSens Smartbox
- GroSens Converter
- Ethernet Extender (if required)
- Power over Ethernet (PoE) injector

All elements of a standard GroSens System are described in appendix 8.6.

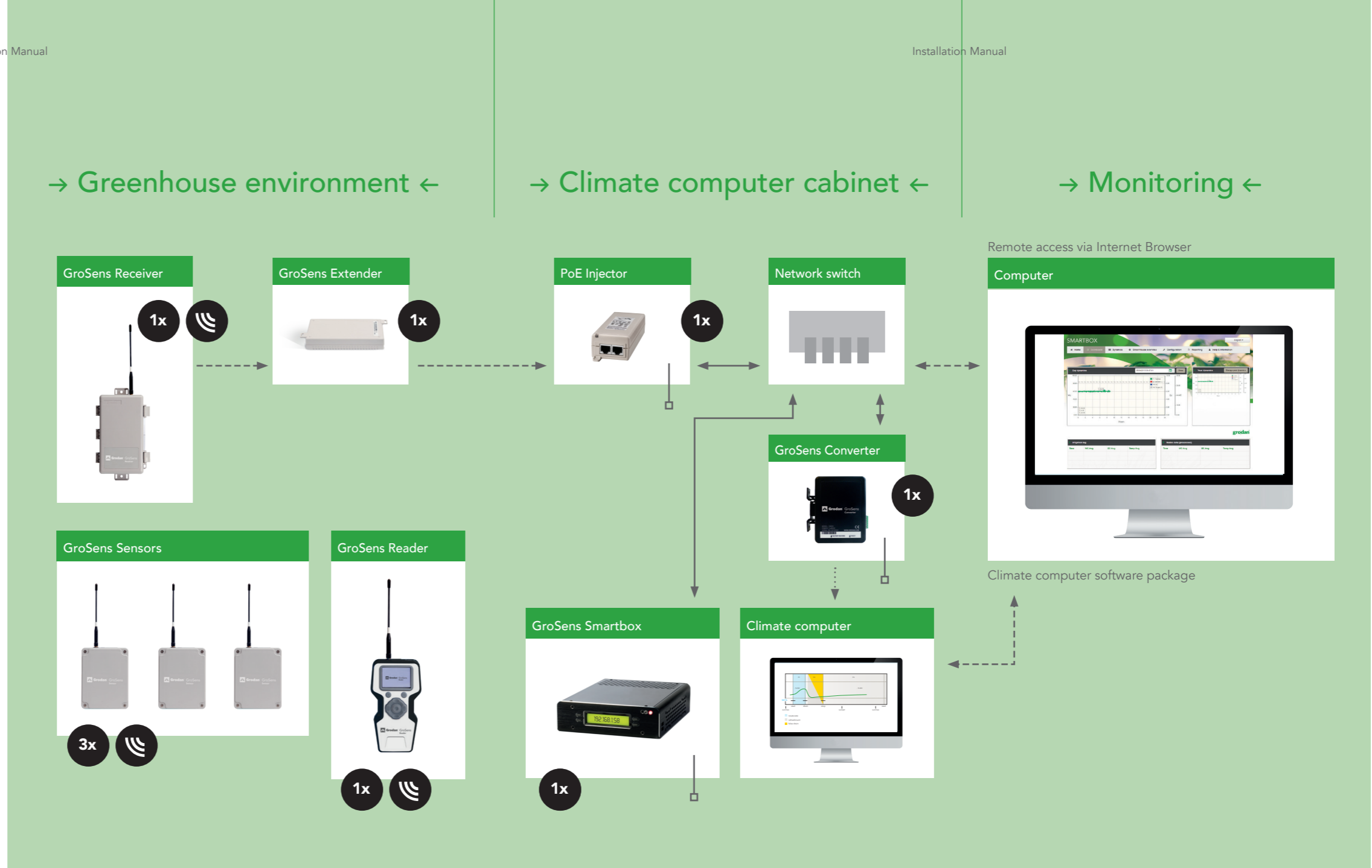

1.1 Before installation

For a fast installation of the GroSens System, make sure the following items are in place:

IT

- An extra LAN (Local Area Network) that can be used for the GroSens System. This LAN needs to be separate from the climate computer LAN.
- 3 to 6 connections on the LAN, each with its own IP address.

Installation

- Enough UTP Ethernet cable (Cat. 5e) to connect the GroSens Receiver and GroSens Smartbox.
- There should be 3-6 free electricity sockets available for the PoE injector, Smartbox, and Converter (the Converter can also be powered with 12 V from the climate computer cabinet).
- 3 free analogue connections to the climate computer. The GroSens System will communicate 3 separate signals: WC, EC and Temperature. These signals are 0-5 Volt signals. In case this is not available or unknown, contact the climate computer supplier.
- There must be a LAN (Ethernet) connection in the climate computer cabinet.

1.2 Installation steps

The following steps need to be completed to install a GroSens System successfully:

Hardware installation: Described in section 2

Software installation: Described in section 3

Connection to climate computer: Described in section 4

The different components and the connections between them are shown in the figure above. The numbers in parentheses show the number of these components in a standard GroSens System package.

Legenda

- Ethernet cable (3x)
- Adapter (3x)
- - - - Ethernet UTP cable CAT5, 5e or 6 (not included)
- Analogue cable

2 Hardware installation

2.1 General

Before starting to install the system, the rough location of the GroSens Sensors should be defined. The maximum distance from the GroSens Sensors to the GroSens Receiver is 50 meters. Due to the growth of the crop, the distance will be larger at the start of the season than at the end. The Sensors that are in the same irrigation section should be used to calculate the average of that section.

As shown in the overview, the GroSens Smartbox, GroSens Receiver and GroSens Converter need to be connected to the LAN. Most growers also have a specific climate computer digital network, operating with similar Ethernet cables. Do not connect the GroSens System to this network. The power supplies must be connected to the 110-230 V~ net with the appropriate plugs.

As shown in the overview, all the provided adapters should be outside the greenhouse and connected to the appropriate device.

The hardware must be installed in the following order:

1. Connect first set of cables (Section 2.2)
 - a. GroSens Smartbox & Network Switch
 - b. Network Switch & PoE Injector
2. Connect power to GroSens Smartbox (Section 2.3)
3. Connect second set of cables (Section 2.4)
 - a. GroSens Receiver & PoE Injector (including GroSens Ethernet Extender if required)
4. Activate Sensors (Section 2.5)

Please note: Ensure that conditions are dry when installing the various parts at the locations. Preferably do not install in direct sunlight or in a very hot place.

2.2 Connecting first set of cables

The GroSens Smartbox should be connected to the Network Switch. From the Network Switch, a second cable is required to the PoE injector. The Ethernet cables provided can be used for both connections. Provide power to the PoE injector if required.

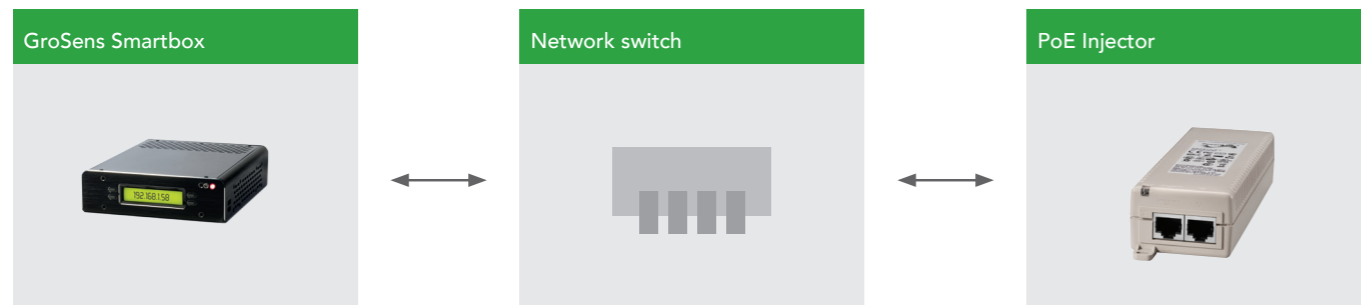

2.3 Smartbox

After connecting all cables and powering on the GroSens Smartbox, the Smartbox LCD should immediately display "Loading...". After about 50 seconds, the LCD should switch to a screen that displays the GroSens Smartbox IP address assigned by the router, the Smartbox identity (initially set to its serial number) and the current (Los Angeles) time. Make a note of the IP address – it will be important for the next steps.



GroSens Smartbox

Please note: It is not necessary to plug in a keyboard and monitor to the Smartbox for installation. The option is available but only for repair purposes. In that case, the GroSens Smartbox works best with a VGA monitor.

2.4 Connecting second set of cables

Option 1

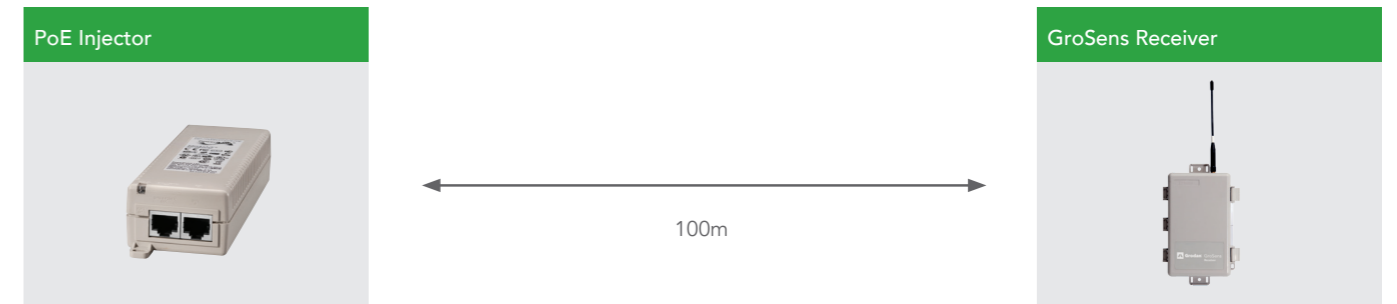

Option 2

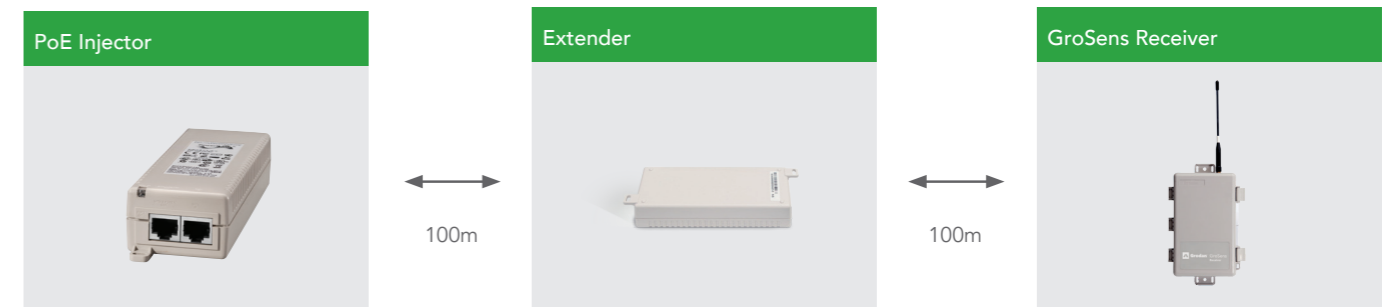

As alternative to the extender, also a switchbox can be used every 100 meter.

This is specially recommended if:

- there is already internet available in the Greenhouse
- more than 2 extenders/amplifiers are needed to cover larger distances.

Please note: For a switchbox a power socket is needed. In case of a switchbox, the PoE connection of the Receiver should be placed after the switchbox. At that connection point 2 power sockets are needed.

A Switchbox is not included in the package but can be obtained at a local IT/computer store.

First, the long cable into the greenhouse should be connected to the Receiver. The correct RJ45 outlet must be used when connecting the PoE injector to the GroSens Receiver. The outlet is located inside the GroSens Receiver housing (see below).



GroSens Receiver

When the GroSens Receiver is connected to the PoE Injector, two LEDs should light up: the Power LED and Link LED. The Power LED will light up immediately. The link LED will turn on as soon as the GroSens Receiver has auto-discovered the GroSens Smartbox; this can take several minutes. Wait until the Link LED is lit before continuing the installation process. After the connection is made, the housing can be closed.



The cable between the PoE injector outside the greenhouse and the Receiver inside the greenhouse cannot be longer than 100 metres (see option 1). Standard Ethernet cables: Cat5e is sufficient.

If the distance between the PoE injector and the Receiver is greater than 100 meters, an Extender or Switchbox must be installed after every 100 metres of cable (see option 2). There is one Extender provided in the set. The maximum distance from the PoE Injector to the Receiver is 200 metres. Extra Extenders to extend the maximum distance can be ordered from Grodan Customer Service if required.

It is best to locate the GroSens Receiver above the highest point of the crop (at the end of the season). Position the Sensors in the centre of the area and, for better wireless reception, as far as possible from steel poles or other heavy greenhouse structures. Fasten the Receiver with a tie-wrap or another sort of easily removable mounting device in case the Receiver needs to be relocated if the GroSens Sensors get out of range.

Please note: You must install the GroSens Smartbox first, as indicated in the installation sequence. The GroSens Receiver will only connect to a GroSens Smartbox that is already running. The Receiver requires 24V of power. This can also be realised by using a standard 24V adaptor. The adaptor should output DC voltage between 12-30 volts, capable of supplying 500 milliamps of current.

2.5 GroSens Sensors

The GroSens Sensors need to be positioned within a 50 metre radius of the GroSens Receiver. The following steps should be taken:

1. Determine roughly the spot where the GroSens Sensors need to be placed.
2. Perform a set of measurements with the GroSens Reader close to the chosen spot. See the GroSens Reader manual for more instructions.
3. Determine a representative location and place a GroSens Sensor.



GroSens Sensors

4. Activate the GroSens Sensor by pushing the TEST button. After activation, both LEDs will light up and, after a few minutes, only the green LED will glow:
 - The green LED indicates round-trip communication with the GroSens Smartbox.
 - The red LED indicates a problem communicating with the GroSens Smartbox.
5. You will not need to change GroSens Sensor settings for installation. The settings can be changed with the GroSens Reader if needed:
 - Select your network (i.e. System Identity)
 - Go to the Device screen
 - Press the TEST button on the Sensor
 - Select the Sensor in the list.

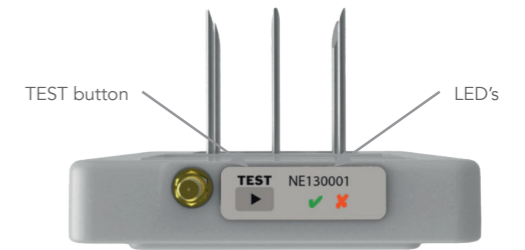

2.6 How to install the Sensors in the greenhouse

Place a Sensor 8 – 10 cm left from the 2nd block from the drain hole. The antenna should be placed furthest away from the 2nd block. This can be found in drawings on the right.

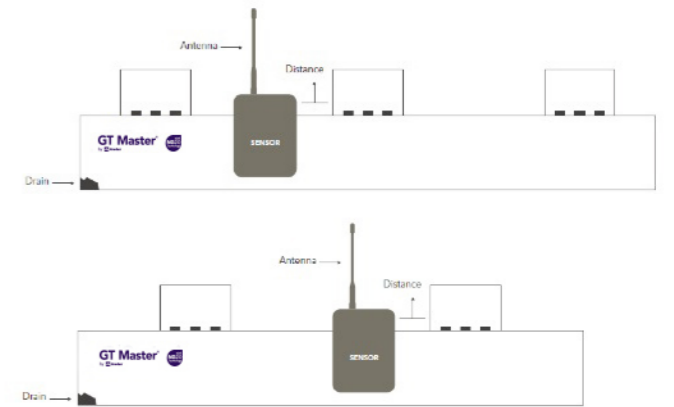

In case the cropping system is different and the former mentioned rule cannot be applied, please contact Grodan Customer Service.

2.7 Setting the correct plate height

For all slabs with a height of 7,5 cm:

- The guiding plate should be positioned in the lowest position. This is the position the Sensors are normally delivered to customers. See picture:

For all slabs with a height of 10 cm:

- The guiding plate should be positioned in the upper position. See picture:



3 Software installation Smartbox

3.1 General

All hardware is preinstalled with the standard software necessary. This section highlights the steps necessary to apply custom settings.

3.2 Login

Log in with a computer plugged into the router or connected to the network switch with an ethernet cable. Go to the IP address listed on the Smartbox LCD screen (e.g. <http://192.168.1.58/>).

It takes about 20 seconds to load the login screen.

On the start page, your preferred language can be set using the drop down menu in the top right-hand corner.

Access to the GroSens Smartbox is protected with a username and password. Usernames and passwords are created at installation.

Clicking the "log in" button will redirect you to the "dashboard page" or "starting page".

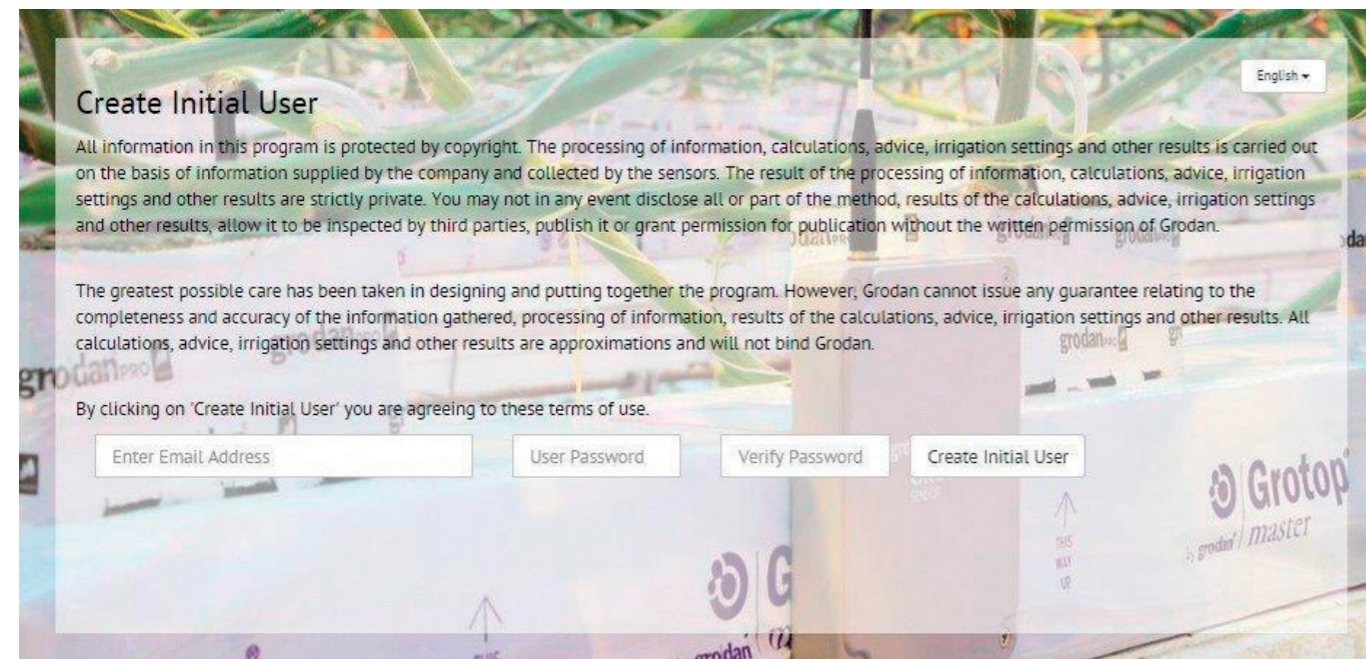

If you use a valid email address to create a user, dont forget to set the notification level at none! this can be done in the manage users function (see 5.2.2)

3.3 Devices section (shortcut button)

The devices overview shows how your GroSens System is configured in the greenhouse in a non-graphical format. It also tells you how the complete systems are operating.

The information from the Sensors is displayed in table format, grouped by irrigation section. The information from the Reader, Converters and Receivers is grouped in a separate section. If all bullets are green or yellow, everything is working fine. If a red bullet is shown, the device does not work and action is needed.

Status	DeviceSN	Row & Offset	Last Readings		Last Update
	NE150722	16, 1	83.7% VWC	4.57 dS/m	22 seconds
	NE150723	5, 4	64.4% VWC	3.86 dS/m	20 seconds
	NE150732	1, 2	75.5% VWC	4.04 dS/m	7 seconds
Average			74.5% VWC	4.16 dS/m	21.7°C

3.4 Irrigation section and Sensors

Status	DeviceSN	Row & Offset	Last Readings		Last Update
	NE150722	16, 1	83.7% VWC	4.57 dS/m	22 seconds
	NE150723	5, 4	64.4% VWC	3.86 dS/m	20 seconds
	NE150732	1, 2	75.5% VWC	4.04 dS/m	7 seconds
Average			74.5% VWC	4.16 dS/m	21.7°C

Field/Function	Description
Section: Section 1	Clicking the section name takes you to the graph of that section (see Chapter 3 User Manual).
	Clicking the cogwheel takes you to the section settings (see Chapter 4 User Manual).
Status	The Status section provides information about device errors: <ul style="list-style-type: none"> - A green dot is shown if data from the GroSens Sensor has been received by the GroSens Smartbox. - A yellow triangle is shown if the Sensor has not delivered data in the last 10 minutes. - A red icon is shown if the device is not working or not connected. - The battery icon indicates the Sensor battery status: <ul style="list-style-type: none"> - green: ok - yellow: less than 30% capacity – it is advisable to replace the batteries - red: you should replace the batteries immediately as no data is being received - Signal strength icon: <ul style="list-style-type: none"> - green: Sensor is working ok - yellow: Sensor is working but it is advisable to move it closer to the Receiver or you might lose the connection - red: signal strength is low – move the Sensor closer to the Receiver. Data might not be received because the Sensor is too far from the Receiver
DeviceSN	This column displays the name of the GroSens Sensor. Clicking the Sensor number takes you to the section, where you can enter a row and offset for this Sensor.
WC, EC, T	These columns show the latest values received from the GroSens Sensor. Clicking any of the values takes you to the detailed chart for that Sensor.
Average	This column displays whether the data from the GroSens Sensor has been used to calculate the average WC, EC and T for the section.
Last Update	This shows the date and time when the values from the GroSens Sensor were last checked and updated.

3.5 Other devices

Receivers, Converters, and other Devices				
Status	DeviceSN	Type	IP Address	Last Update
✓	C001C226	Converter	10.31.34.36	45 seconds
✓	HE001290		n/a	1 minute
✓	RE141076	Gateway	10.31.34.44	46 seconds

Field/Function	Description
	Clicking the cogwheel takes you to the section settings (see Chapter 4 User Manual).
Status	The Status section provides information about device errors:
✓	- A green dot is shown if the data from the GroSens Sensor has been received by the GroSens Smartbox.
⚠	- A yellow triangle is shown if the device has not delivered data in the last 10 minutes.
❌	- A red icon is shown if the device is not working or not connected.
DeviceSN	This column displays the name and serial number of the GroSens device. - CO is a Converter - HE is a HandHeld - RE is a Receiver
Type	This column displays the type of device: Reader, Receiver or Converter
Average	This column displays the device's IP address (n/a = not applicable).
Last Update	This shows the date and time when the values from the GroSens devices were last checked and updated.

3.6 Create new section

This function allows you to create and configure an irrigation section in which Sensors can be placed. When you select this function, the following picture will appear and display the section settings. There are three sub-screens to complete:

- Section Settings
- Monitoring
 - Add Sensor
 - Select Sensor
 - Row and Offset – configure a Sensor
- Irrigation Control – connect a Converter

3.7 Section settings

Here you can give the section a name and choose the proper slab type or media type. Make sure the slab type is correctly configured – this is described in section 3.8.

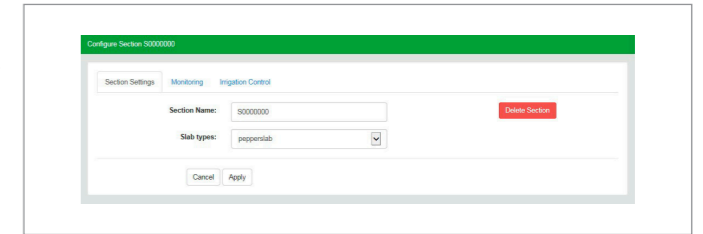

Important!
Click "Apply" to save the settings.

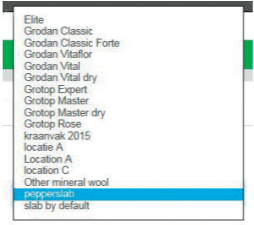
Field/Function	Description
Section name	Enter the name for this section
Media type	Choose the correct slab type for this section via the drop down menu. Make sure it is configured correctly – see 5.1.3. 
Cancel	If you click "Cancel", section creation will be aborted.
Apply	Saves the settings.
Delete Section	If you are configuring an existing section, e.g. section A, the "Delete" button will appear. This will enable you to delete a section. Be aware that all the information will be lost.

3.8 Monitoring - adding and configuring Sensors

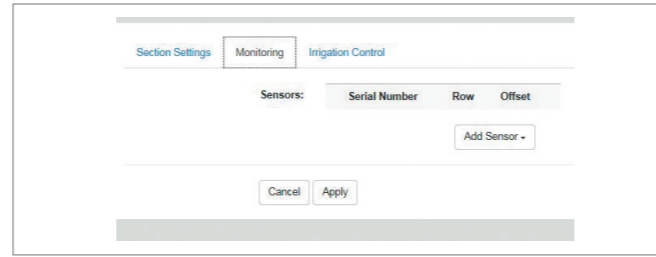

3.8.1 Adding Sensors

When you click "Monitoring", the window shown right will appear.

Field/Function	Description
Add Sensor	<p>Clicking this dropdown menu opens a list of all the Sensors connected to the system along with their sections. You can select a Sensor by clicking its number. After selecting a Sensor it will appear in the section</p>
Row	This is the row in which the GroSens Sensor is located. If the field is blank, you can enter a number.
Offset	This shows the post in the row where the GroSens Sensor is located. If the field is blank, you can enter a number.
	Clicking the cross deletes a Sensor from that section and takes you back to the pool. It may take 20 seconds for it to appear in the pool.
Cancel	If you click "Cancel", section creation will be aborted.
Apply	Saves the settings.

3.8.2 Row and offset – configuring a Sensor

When you click the row or offset number in the screen, you will see the following window which allows you to configure a Sensor:

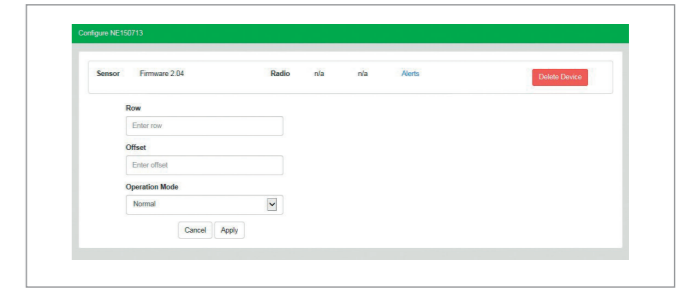

Field/Function	Description															
Row	This is the row in which the GroSens Sensor is located. If this field is blank, you can enter a number.															
Offset	This is the post in the row where the GroSens Sensor is located. If this field is blank, you can enter a number.															
Operation mode	<p>When you click this function, a dropdown menu will appear. The Sensor is set to normal mode.</p>															
Cancel	If you click "Cancel", section creation will be aborted.															
Apply	Saves the settings.															
Alerts	<p>Clicking this button opens a window which gives you detailed information on recent alerts. Clicking the dashboard icon (■) returns you to the dashboard.</p> <table border="1"> <thead> <tr> <th>Date/Time</th> <th>Alert</th> <th>Count</th> </tr> </thead> <tbody> <tr> <td>2015-09-09 07:15:32.760529</td> <td>Sensor NE150722 has poor radio signal.</td> <td>1</td> </tr> <tr> <td>2015-09-09 06:09:32.578426</td> <td>Sensor NE150722 has successfully reported data (back online).</td> <td>1</td> </tr> <tr> <td>2015-09-09 06:07:02.699442</td> <td>Sensor NE150722 has not reported data recently (offline).</td> <td>1</td> </tr> <tr> <td>2015-09-08 17:42:42.005391</td> <td>Sensor NE150722 has poor radio signal.</td> <td>1</td> </tr> </tbody> </table>	Date/Time	Alert	Count	2015-09-09 07:15:32.760529	Sensor NE150722 has poor radio signal.	1	2015-09-09 06:09:32.578426	Sensor NE150722 has successfully reported data (back online).	1	2015-09-09 06:07:02.699442	Sensor NE150722 has not reported data recently (offline).	1	2015-09-08 17:42:42.005391	Sensor NE150722 has poor radio signal.	1
Date/Time	Alert	Count														
2015-09-09 07:15:32.760529	Sensor NE150722 has poor radio signal.	1														
2015-09-09 06:09:32.578426	Sensor NE150722 has successfully reported data (back online).	1														
2015-09-09 06:07:02.699442	Sensor NE150722 has not reported data recently (offline).	1														
2015-09-08 17:42:42.005391	Sensor NE150722 has poor radio signal.	1														
Delete Device	<p>Activating the delete function completely removes the Sensor from the Smartbox System.</p> <p>After deleting you can restore the Sensor by clicking the test button.</p>															

3.9 Sunrise/sunset and lighting setup

In this menu you can select whether you use artificial or natural lighting:

- For natural light, you will need to enter the longitude and latitude to display sunrise and sunset in the graphs (yellow blocks and time). Data is gathered every 3 minutes during daylight hours and every 30 minutes during the night.
- When artificial light is chosen, lighting time intervals can be set. During the set lighting time period, data will be gathered every 3 minutes.

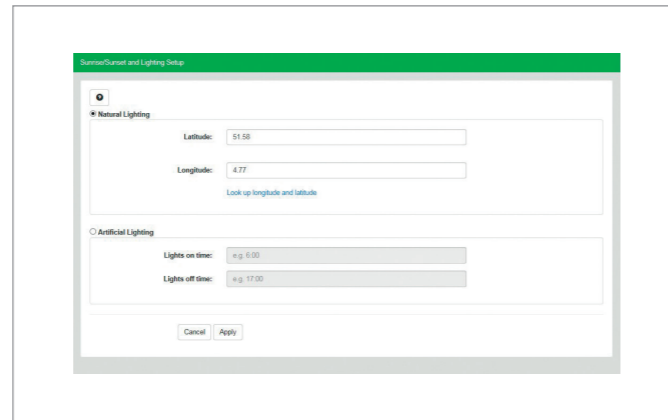

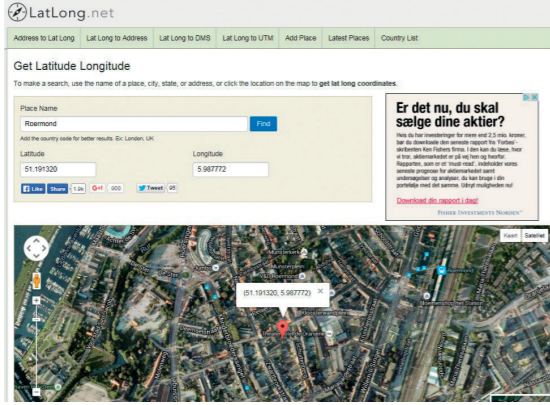
Field/Function	Description
Natural Lighting	Check this option if you are using natural lighting.
Latitude	Shows the latitude.
Longitude	Shows the longitude.
Get Latitude Longitude	When you click this function, you will be taken to Google Maps to help you find the appropriate latitude and longitude. You can copy and paste the values into this page. 
Artificial Lighting	Check this option if you are using artificial lighting.
Lights on time	Time when lights go on.
Lights off time	Time when lights go off.
Apply	Click "Apply" to save the new values.

3.10 System date, time and time zone

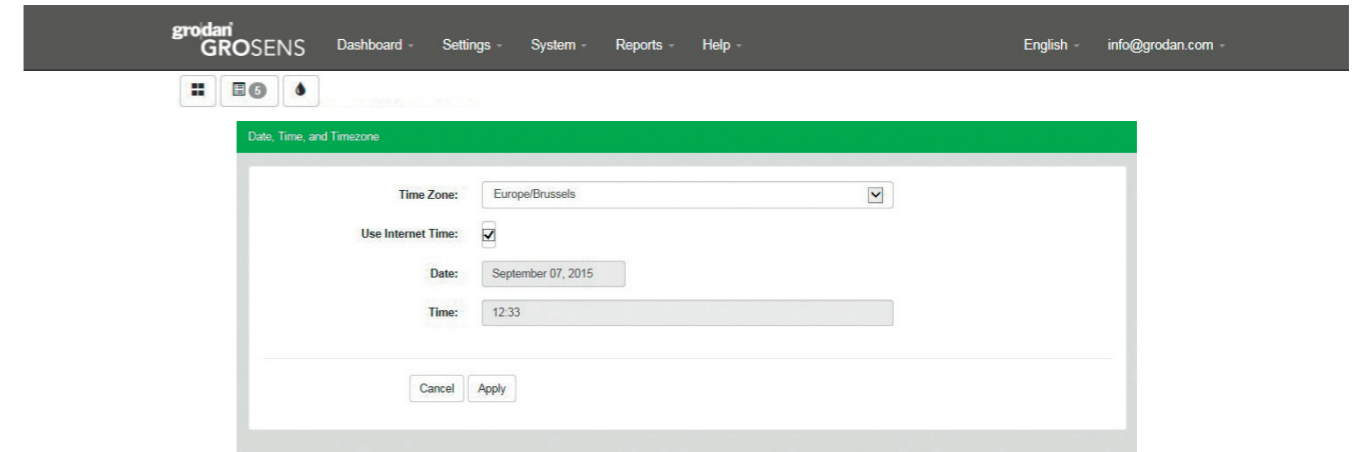

Field/Function	Description
Time Zone	The time zone where the GroSens System is located.
Use Internet Time	Use internet time as default (highly recommended).
Date	Current date.
Time	Current time.
Update	Click "Update" to save the new values.

3.11 Update

When you click this function, the system will check whether there are any software updates available.

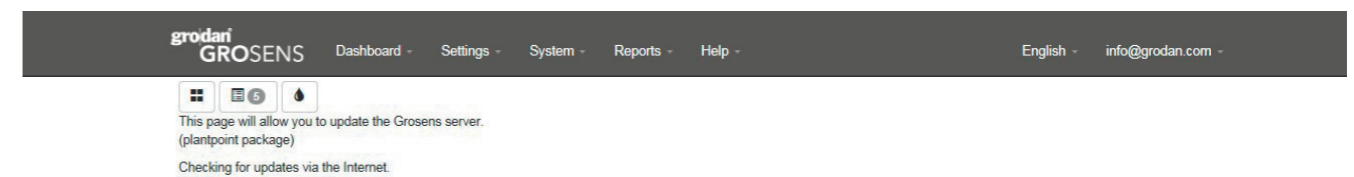



3.12 Manage users – authorisation levels

In this section you can add extra usernames and passwords so other employees can have access to the Smartbox System. You can also set the user level.

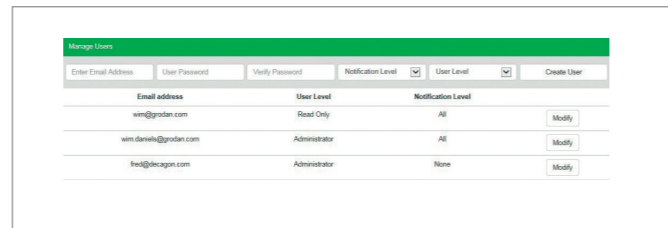
Note: the notification level should be set to “None”.

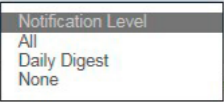
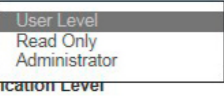

Field/Function	Description
Enter email address	Specify the username in this field in the form of an email address.
User Password	Enter the password in this field.
Verify password	Verify the password by entering it again.
Notification level	Notification level should be set at “None”. If you select “All”, all alerts are sent to your email address 
User Level	You can choose between “Read Only” – this will only enable you to view the graphs – or “Administrator”. In the administrator role you have access to all menus in the software. 
Create User	Clicking “Create User” saves the settings for the defined new user.
Modify User	Clicking “Modify” after a defined user enables you to modify the settings, including the password. You can also remove a previously defined user. 

4 Connection to climate computer

4.1 Hardware Installation

- The GroSens Converter has the following outputs: Check whether the climate computer has 3 free analogue connection points. If they are available, proceed with further installation. If not, contact the climate computer installer.
- The GroSens Converter needs to be connected to the Network Switch and climate computer. A cable is supplied for the connection between the Converter and the Network Switch.
- For the connection between the GroSens Converter and the climate computer, a simple wire cable can be used.

GroSens Converter Output		
WC	Water Content (WC)	0-5V output representing average water content of the section
EC	Electric Conductivity (EC)	0-5V output representing average electrical conductivity of the section
TEMP	Temperature (Temp)	0-5V output representing average temperature of the section





- The Converter can be powered on after connection and checking the other parts of the GroSens set. Optionally, the Converter can also be fed with 12V from the climate computer cabinet in which it is installed.
- The Converter has a flexible mounting bracket. It will simply snap onto a standard-sized DIN rail found in many climate computer enclosures. Alternatively, the bracket can be mounted with screws directly to a wall with the Converter then clipped onto the mounting bracket.
- The labelled ports on the Converter: ‘WC’, ‘EC’ and ‘Temp’ should be connected to the climate computer.

4.2 Software installation

After following the procedure for the hardware installation of the Converter and when the Link LED is constantly lit, the following steps need to be completed:

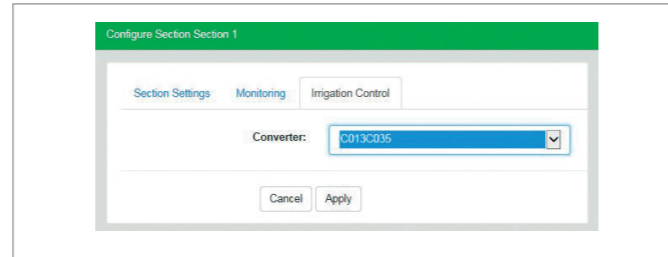
1. Click on the cog wheel of the section, the convertor should be assigned to
2. Click "irrigation settings"
3. Irrigation control – connecting a Converter
Clicking the "Irrigation Control" tab takes you to the following window, in which you can configure a Converter:



Field/Function	Description
Required Irrigation Supply	For future use, in development
Converter	If you click the dropdown menu, the following screen will appear with connected Converters. Select the Converter you want to attach to this section from the list. 
Irrigation Priority	For future use, in development
Cancel	If you click "Cancel", section creation will be aborted.
Apply	Saves the settings.

Now the GroSens Converter can receive commands from the GroSens Smartbox and send the analogue information to the Climate Computer.

4. As a last step, it is important to check the values in the Climate Computer. The values should be identical to the GroSens Smartbox. If the values are different, the voltage needs to be checked.
5. If different settings in voltage are needed due to different voltage settings of the climate computer, go to "Converter settings" in the menu settings

4.3 Converter settings

The Converter settings are configured as described below. They can be edited if necessary by entering the required values. Click "Apply" to save your settings.

If you have edited values and you want to reset the original figures, click "Load original settings".

For more information on how to use the system and software functionalities, please read the GroSens user manual.

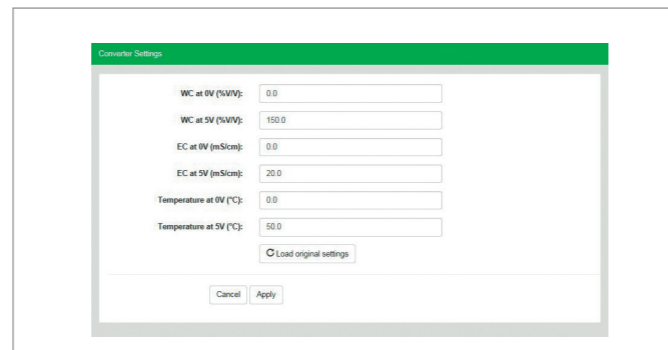

5 Troubleshooting

If no graph is visible on the web user interface or climate computer, try the following:

- Check the status LEDs of all GroSens devices. Review the installation procedure of hardware and software if a red LED is lit.
- Check the GroSens System parts. This can be done in the "Grower settings - overview" screen in the web user interface (see Sections 3.3., 3.4 and 3.5). All status icons need to be green and data should be refreshed every 3 minutes.
- Check whether the GroSens devices are visible in the network with an IP-scan program. If no devices can be found, restart the GroSens Smartbox (see Section 8.4).

In the event that the Link LED is not lit on the Converter, try the following:

- On the GroSens Converter is a Reset button. Press and hold this button for 5 seconds. If this doesn't fix the issue, press and hold the Restore button on the Converter for 5 seconds. This will restore the Converter to factory settings.

If these actions or checks do not fix the issue, please don't hesitate to contact Grodan.

6 Maintenance

The GroSens System requires no special maintenance, with the exception of software updates via the Internet. Updates can be installed automatically by clicking on the "Grower settings - check for update" option in the installation menu (see Section 3.5).

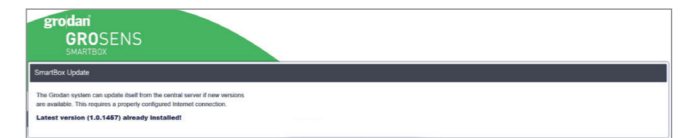

Calibration of the GroSens Sensors is not required. Each Sensor has 4 AA batteries. The storage level of the batteries is shown in the installation status screen of all Sensors.

A warning is displayed before the battery level goes under the lower limit. You will normally have to change the batteries once a year before the start of a new crop.

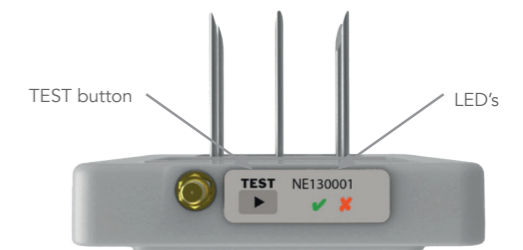

7 Range and accuracy

The GroSens System measures Water Content (WC), Electric Conductivity (EC) and Temperature (Temp). The table on the right provides accuracy information of the GroSens Sensor.

The accuracy decreases slowly towards the borders of the respective ranges and is not guaranteed outside them.

Type	Range	Accuracy	Resolution
Water Content (WC)	0-100% V/v	5% V/V	0.1% V/V
Electric Conductivity (EC)	0-10 mS/cm	0.5 mS/cm	0.01 mS/cm
Temperature (Temp)	0-50°C	1°C	0.05°C

8 Warranty

For Warranty information, please contact our Customer Service Departments.

For US and Canada:

Roxul Inc. - Grodan
 8024 Esquesing Line
 Milton ON L9T 6W3
 Canada Phone : (1) 905 636 0611

For other countries contact the head office:

Rockwool BV - Grodan
 Industrieweg 15 5045 JG Roermond the Netherlands
 Phone : (31) 475 353 020
 email: info@Grodan.com
 www.grodan.com

9 Appendices

9.1 Sensor

The GroSens Sensors have two functions:

1. They perform measurements in the slab at a regular time interval. To determine the right measurement location of the Sensor, see Section 3.4.
2. They send the measured data wirelessly to the GroSens Receiver. The Sensor automatically searches for a connection to a Receiver. No settings are needed here. The wireless frequency depends on where you are in the world.

The Sensor is equipped with:

- A green LED that blinks briefly every minute when in full operation and all conditions are satisfactory.
- A red LED that is lit when there is no communication.
- TEST button: In the case of a poor or lost connection, push the TEST button once. The Sensor will start searching for a Receiver again until a connection is established.
- The GroSens Sensor is rated at IP65 and is built with protected boards (EMC).



In the stone wool slab



9.2 Reader

The GroSens Reader has the following functions:

1. It adjusts Sensor and Section settings.
2. It displays WC, EC and T measurements from a GroSens Sensor.
3. It tests the wireless connectivity of a Receiver or a Sensor.



Handheld device



9.3 Receiver

The GroSens Receiver has one function:

1. It controls wireless dataflow between the GroSens Sensors and the GroSens Smartbox.



The GroSens Receiver is equipped with two LEDs:

- The Power LED indicates if the Receiver is powered.
- The Link LED indicates whether the Receiver is connected to the GroSens Smartbox.



Centrally positioned in the greenhouse



9.4 Smartbox

The GroSens Smartbox is a small computer that has the following tasks:

1. It connects to the GroSens Receiver over Ethernet to gather the measured data.
2. It stores the data and maintains a log of all GroSens devices connected to the LAN.
3. It translates the raw measurements into figures.
4. It creates averages of GroSens Sensor data over the chosen sections of the greenhouse according to the grower's wishes.
5. It transmits an alarm if the system devices do not function properly.
6. It stores custom settings to perform necessary calculations.
7. It connects over the Internet to download updates.

The GroSens Smartbox is equipped with:

- LCD Screen - The Smartbox menu can be accessed by pressing the button in the lower left-hand corner of the Smartbox front panel:
- Shut down – This menu option can be used to manually shut down the Smartbox device. This can be useful when transitioning to another Smartbox device, or before storing the Smartbox after the end of the growing season. To shut down the Smartbox, simply press the button next to the checkmark icon on the LCD display.
- Restart –The Restart menu option can be found by pressing the bottom-left button again. To restart the Smartbox, simply press the button next to the checkmark icon on the LCD display.
- Restore DHCP Network Settings –This option can be used to reset the IP Address, Gateway, and Netmask to their default values assigned by your router. This can be beneficial if the Smartbox cannot connect to the network. To restore the default network settings, press the button next to the checkmark icon (✓) on the LCD display.
Please note: Using DHCP settings is recommended.
- Enable VPN – A VPN (Virtual Private Network) can be used to enable technical support personnel to inspect and repair any issues that may arise with the GroSens System. To enable a VPN, press the checkmark button. To disable the VPN, press the button next to the 'X' on the LCD display.
- Version Number – This displays the current version of the Smartbox software.



Close to the climate computer

1x

9.5 Converter (climate computer analogue interface)

The GroSens Converter has one task:

1. It translates the data from multiple GroSens Sensors to the climate computer's analogue input module. The Converter can be connected to any type of climate computer that can receive 0-5V input. Otherwise, please consult your climate computer supplier for advice.



In between Smartbox and climate computer

1x

9.6 Overview of standard GroSens System



GroSens Sensor (wireless)

The Sensors give an extremely accurate measurement of WC, EC and temperature in the stone wool substrate.

GroSens Converter

The Converter converts the digital information in the Smartbox to analogue output. This makes the GroSens system connectable to most climate-control systems.

GroSens Smartbox

The Smartbox processes the data from the sensors, taking the slab type and dimension into account. The WC, EC and temperature measurements are transmitted to the climate-control computer and can be viewed on any external computer connected to the grower's Internet / Ethernet site.

GroSens Reader

The Reader enables easy installation and can also be used as a handheld device to quickly get figures from a GroSens sensor as you walk through the greenhouse.

GroSens Receiver

The Receiver picks up the signals from the Sensors.

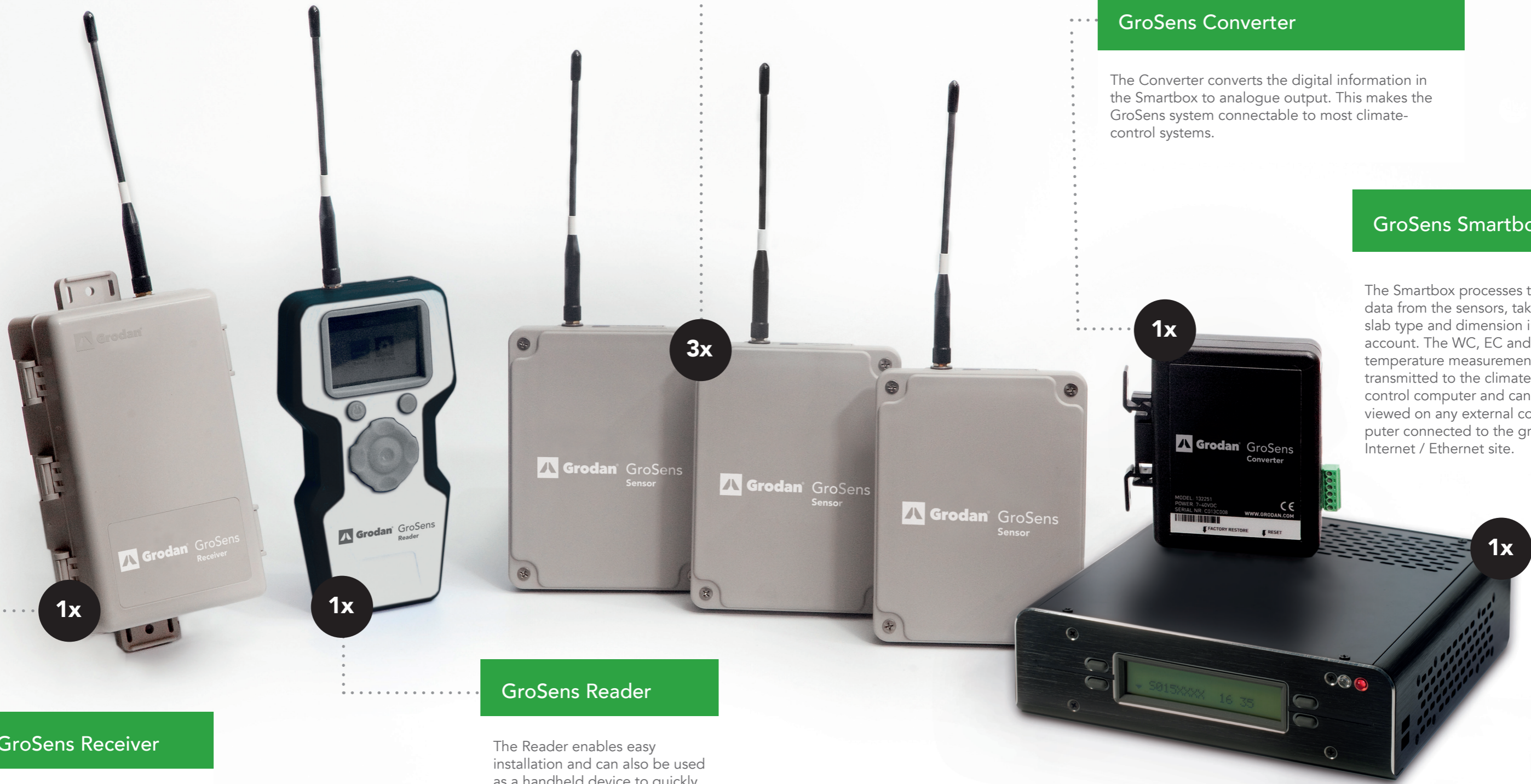

The GroSens System, -Smartbox, -Sensor and Sensor design, are patented technologies.

9.7 Radio Frequency - declaration of Conformity

European kitt: Europe and Russia

The Grodan GroSens wireless sensing system uses license-free radio frequencies to communicate Sensor data. These wireless devices constitute 'short range device' (SRD).

Applicable Material Numbers:	GroSens Sensor 132253, GroSens Receiver 132256, GroSens Reader 132260, (EUR system)
Operating Frequency Range:	863-870 MHz (868 ISM band)
Maximum Output Power:	25 mW (14 dBm) effective radiated power (e.r.p.)
Interference Avoidance Technology:	Listen Before Talk (LBT) + Automatic Frequency Agility (AFA)

EC Declaration of Conformity (for Europe and additional locales)

These products are in conformity with the essential and relevant requirements of the EU Directive 1999/5/EC R&TTE and the EU Directive 2011/65/EU RoHS2

Safety: (article 3.1a)	EN60950-1:2006+A12:2011, EN 62311:2008
EMC: (article 3.1b)	ETSI EN 301 489-1 V1.9.2 (2011-09) in accordance with ETSI EN 301 489-3 V1.4.1 (2002-08)
Spectrum: (article 3.2)	ETSI EN 300 220-2 V2.3.1 (2010-02)



NA – kitt: North America and Australia

The Grodan GroSens wireless sensing system uses license-free radio frequencies to communicate Sensor data. These wireless devices constitute 'short range device' (SRD).

Applicable Material Numbers:	GroSens Sensor 132254, GroSens Receiver 132258, GroSens Reader 132261, (CAN/USA/AUS system)
Operating Frequency Range:	915.6-927.6 MHz (900 MHz ISM band)
Maximum Output Power:	250 mW (24 dBm) effective radiated power (e.r.p.)
Interference Avoidance Technology:	Frequency Hopping Spread Spectrum (FHSS)

EC Declaration of Conformity (for USA)

The devices comply with Part 15 of the FCC Rules. Operation is subject to the following two conditions: (i.) this device may not cause harmful interference and (ii.) this device must accept any interference received, including interference that may cause undesired operation.

Contains FCC ID:	MCQ-XB900HP
-------------------------	-------------



Industry Canada Declaration of Conformity

This device complies with Industry Canada licence-exempt RSS standard(s). Operation is subject to the following two conditions: (1) this device may not cause interference, and (2) this device must accept any interference, including interference that may cause undesired operation of the device.

Le présent appareil est conforme aux CNR d'Industrie Canada applicables aux appareils radio exempts de licence. L'exploitation est autorisée aux deux conditions suivantes: (1) l'appareil ne doit pas produire de brouillage, et (2) l'utilisateur de l'appareil doit accepter tout brouillage radioélectrique subi, même si le brouillage est susceptible d'en compromettre le fonctionnement

Contains IC ID:	1846A-XB900HP
------------------------	---------------

C-Tick Declaration of Conformity (for Australia)

The devices comply with Radiocommunications (Short Range Devices) Standard 2004.

ACMA:	N30375
--------------	--------



Row-lite kitt (Japan)

The Grodan GroSens wireless sensing system uses license-free radio frequencies to communicate Sensor data. These wireless devices constitute 'short range device' (SRD).

Applicable Material Numbers:	GroSens Sensor 188180, GroSens Receiver 188179, GroSens Reader 188181, (RoW-Lite system)
Operating Frequency Range:	2410-2465 MHz (2.4GHz ISM band)
Maximum Output Power:	10 mW (10 dBm) effective radiated power (e.r.p.)
Interference Avoidance Technology:	Direct Sequence of Multiple Channels

EC Declaration of Conformity (for Europe and additional locales)

These products are in conformity with the essential and relevant requirements of the Directive 2004/108/EC (EMC), Directive 2006/95/EC (LVD) and Council Directive 1999/5/EC R&TTE.

Safety: (article 3.1a)	EN60950-1:2006/A12:2011, EN 62311:2008
EMC: (article 3.1b)	ETSI EN 301 489-1 V1.8.1 (2008-04) in accordance with ETSI EN 301 489-17 V2.1.1 (2009-08)
Spectrum: (article 3.2)	ETSI EN 300 328 V1.7.1 (2006-10)



FCC Declaration of Conformity (for USA)

The devices comply with Part 15 of the FCC Rules. Operation is subject to the following two conditions: (i.) this device may not cause harmful interference and (ii.) this device must accept any interference received, including interference that may cause undesired operation.

Contains FCC ID:	OUR-XBEEPRO
-------------------------	-------------



The Grodan Group supplies innovative, sustainable stone wool substrate solutions for the professional horticultural sector. Based on Precision Growing principles, these solutions are particularly applied to the cultivation of vegetables and flowers. In addition to its stone wool substrates, the Grodan Group also provides tailor-made advice and tools to support Precision Growing and thus facilitate the sustainable production of healthy, safe and tasty fresh produce for consumers.

Grodan

Industrieweg 15
Postbus 1160, 6040 KD Roermond
The Netherlands

T +31 (0)475 35 30 20

F +31 (0)475 35 37 16

info@grodan.com

www.grodan.com

www.linkedin.com/company/grodan

www.twitter.com/grodan

Grodan is a registered trademark of ROCKWOOL INTERNATIONAL A/S. © ROCKWOOL B.V.
Grodan 2017. All rights reserved.

